

Promate®

Operator Manual

PM1100i

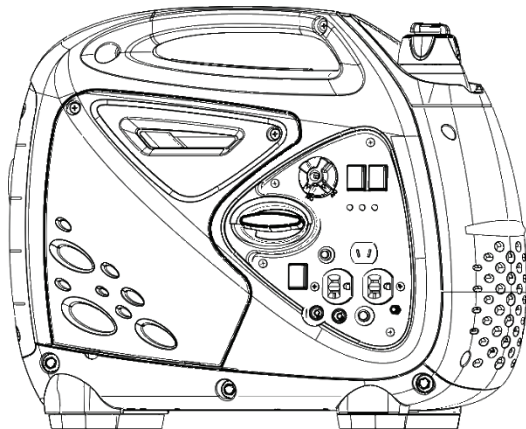

PM2100i

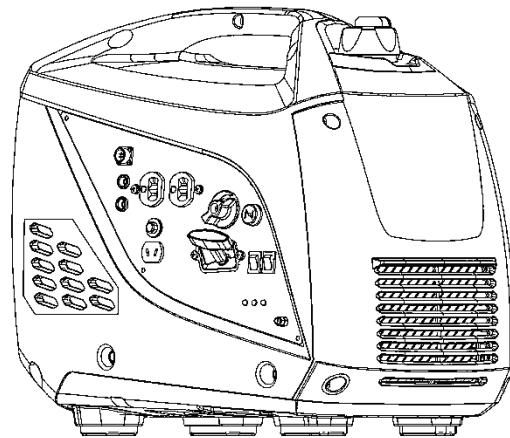

PORTABLE INVERTER GENERATOR

IMPORTANT – Please make certain that persons who are to use this equipment thoroughly read and understand these instructions and any additional instructions provided prior to operation.

Record the model and serial numbers of your Generator below:

Model No. _____ Serial No. _____

FOREWORD

Thank you for purchasing our product. This operator manual is for proper handling, minor checking and maintenance of the generator. Before using your generator: Please read these instructions completely and carefully in order to make the best use of it as well as operate it safely. Due to constant efforts to improve our products, certain procedures and specifications are subject to change without notice, if you have any questions, please contact Promate Service.

CONTENTS

1	Safety Precautions	3
2	Controls and Features	4
3	Before Starting	6
	3-1 Add Engine Oil	6
	3-2 Add Fuel	6
4	Operation	7
	4-1 Starting the Engine	7
	4-2 Economy Control Switch	8
	4-3 Battery Charging	8
	4-4 Stopping the Engine	8
5	Maintenance and Storage	10
	5-1 Engine Maintenance	11
	5-2 Cleaning	11
	5-3 Generator Maintenance	11
	5-4 Service and Storage	12
6	Specifications	13
7	Troubleshooting	14
8	Service Information	15
	Generator Exploded View	16-23

1. Safety Precautions

The electric power generated by the gasoline engine of the generator can be used for many kinds of electric appliances. When handling it, please keep to the following matters. Please make sure you review each precaution carefully.



⚠ WARNING

EXHAUST PRECAUTIONS

- Never inhale exhaust gasses. They contain carbon monoxide, a colorless, odorless and extremely dangerous gas which can cause unconsciousness or death.
- Never operate the generator indoor or in a poorly ventilated area, such as tunnel, cave, etc. Exercise extreme care when operating the generator near people or animals. Keep the exhaust pipe free of foreign objects.

⚠ WARNING

REFUELING PRECAUTIONS

- Do not refuel indoors or in a poorly ventilated area. Be sure to stop the generator prior to refueling. Do not overfill the tank. If fuel is spilt, wipe it away carefully before starting the engine.

⚠ WARNING

WHEN CHARGING THE BATTERY

- Battery electrolyte contains sulfuric acid. Be careful of your eyes, skin and clothing. Flush thoroughly with water and get prompt medical attention in case of contacts, especially if your eyes are affected.
- Charge the battery in a fully ventilated place.
- Be sure to confirm battery polarity.

OTHER SAFETY PRECAUTIONS

- **Be careful of hot parts.**
The muffler and other engine parts become very hot while the engine is running or just

⚠ WARNING

after it has stopped. Operate the engine in a safe area and keep children away from the running engine.

- **Where to use the generator**

Do not use it near flammables. Use it more than 1 meter away from buildings or any other facilities.

- **When using the generator**

Do not tip or move.

Do not cover it with a box or fence it around.

Never unscrew the dipstick when using the generator set, or else scald will be caused by ejective oil. Do not touch the generator in the rain. And, do not splash water or touch with wet hand.

- To avoid an electric shock, ground the generator from the ground terminal.
- Avoid using generator at the place where the ground is not firm.
- Never connect generator to the wiring of a power company.

2. Controls and Features

Read this owner's manual before operating your generator. Familiarize yourself with the location and function of the controls and features. Save this manual for future reference.

Generator

PM1100i

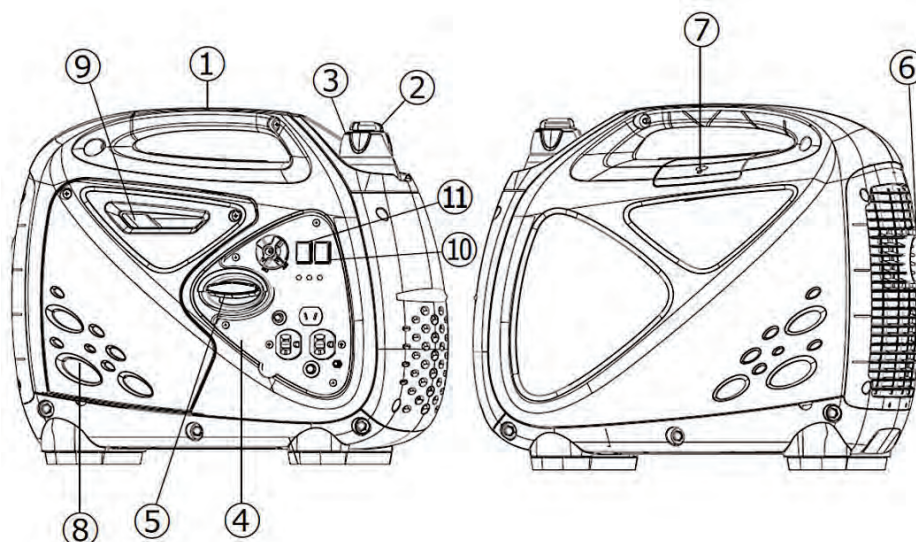

PM2100i

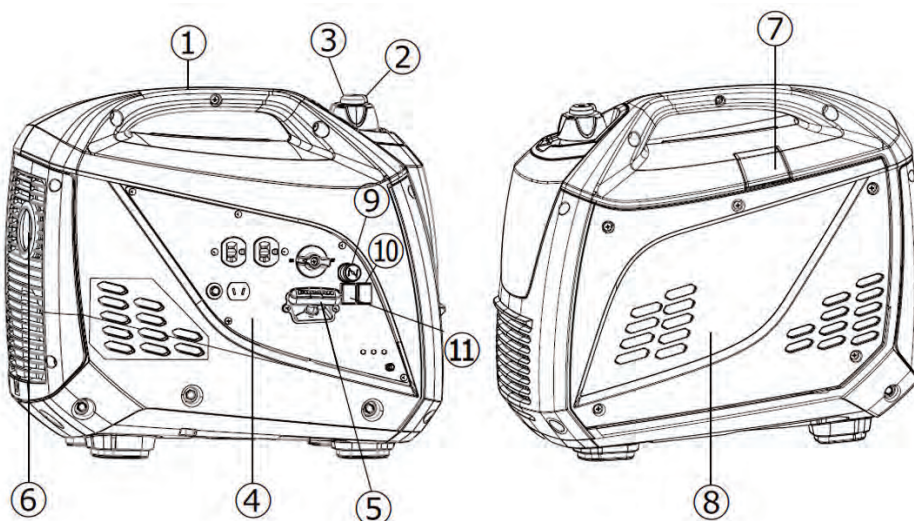

- (1) Carrying Handle
- (2) Fuel Lever Vent
- (3) Fuel Cap
- (4) Control Panel
- (5) Recoil Starter
- (6) Muffler/Spark Arrester

- (7) Spark Plug Access Cover
- (8) Maintenance Cover
- (9) Choke
- (10) Engine ON/OFF Switch
- (11) Economy Control Switch

Control Panel

PM1100i

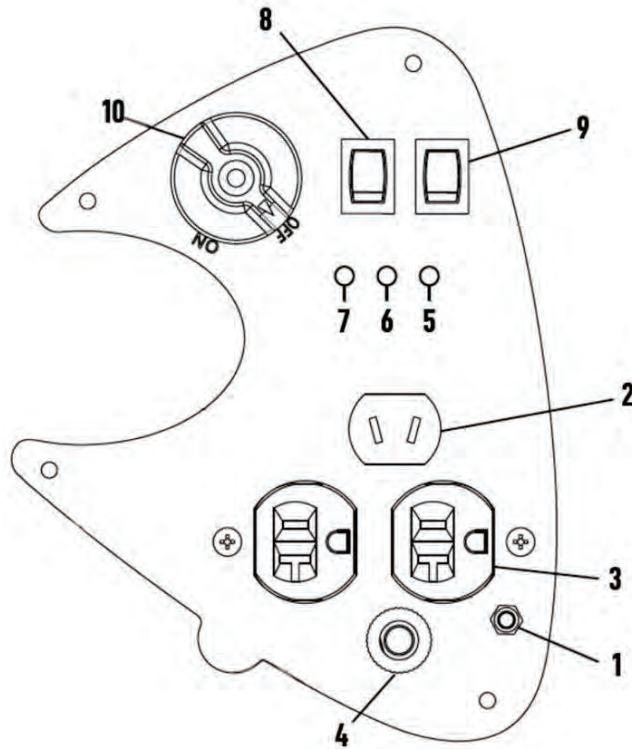

PM2100i

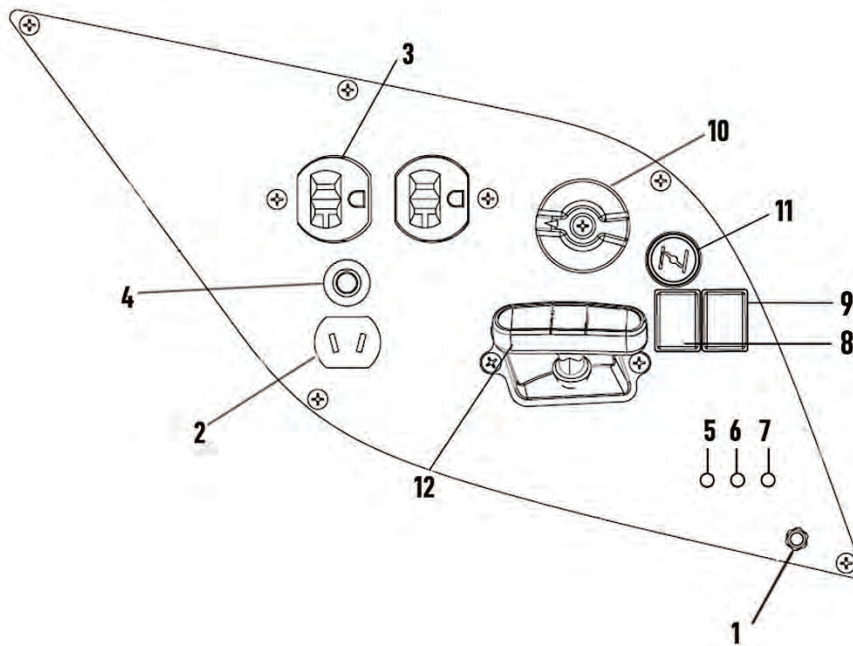

Notice: Total power drawn from all receptacles must not exceed the name plate rating.

- | | |
|---------------------------------|------------------------------------|
| 1. Ground Terminal | 7. Low Oil Warning Indicator Light |
| 2. 1 x 12V DC Outlet | 8. Economic Control Switch |
| 3. 230V Duplex | 9. Engine Switch |
| 4. DC Circuit Breaker | 10. Fuel Valve Knob |
| 5. Output Ready Indicator Light | 11. Choke |
| 6. Overload Indicator Light | 12. Recoil Starter |

3. Before Starting

Your generator requires some assembly. This unit ships from our factory without oil. It must be properly serviced with fuel and oil before operation.

3-1. Add Engine Oil

CAUTION

DO NOT attempt to crank or start the engine before it has been properly filled with the recommended type and amount of oil. Damage to the generator as a result of failure to follow these instructions will void your warranty.

NOTE

We recommend to use SAE 10W-30 API SL oil or 4-cycle automotive oil for best performance. Other high-quality detergent oils (API SL or higher) are acceptable.

1. Place the generator on a flat, level surface.
2. Loosen the cover screw and remove the maintenance cover.

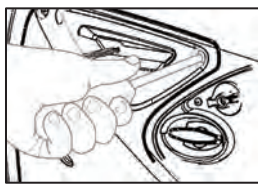

PM1100i

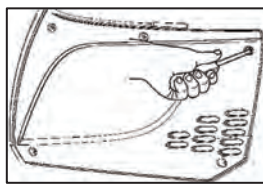

PM2100i

3. Remove oil fill cap/dipstick to add oil.

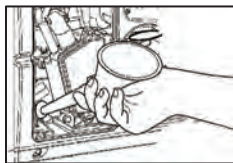

PM1100i

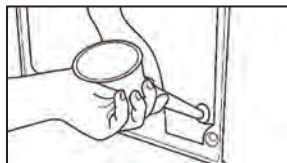

PM2100i

4. Add 0.34 qt (0.32 L) of oil and replace oil fill cap/ dipstick. Check engine oil level daily and add as needed.

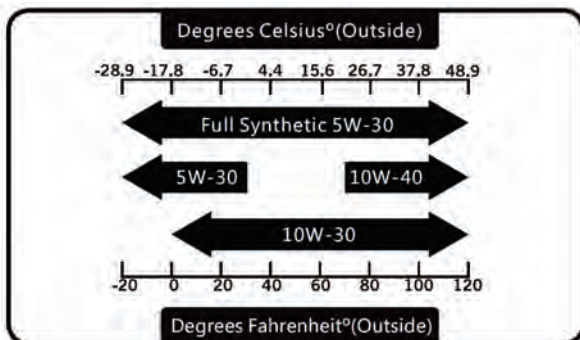

5. Check engine oil level daily and add as needed.

CAUTION

The engine is equipped with a low-oil-shutoff and will stop when the oil level in the crankcase falls below the threshold level.

NOTE

Check oil often during the break-in period. Refer to the Maintenance section for recommended service intervals.

3-2. Add Fuel

1. Use clean, fresh, regular UNLEADED fuel.
2. DO NOT use unapproved gasoline fuel.
3. DO NOT mix oil in gasoline fuel.
4. DO NOT modify engine to run on alternate fuel.
5. DO NOT light a cigarette or smoke when filling the fuel tank.

NOTE

Avoid generator damage. Failure to follow Operator's Manual for fuel recommendations voids warranty.

When Adding Fuel

1. Remove the fuel fill cap and clean the area around it.
2. Slowly add UNLEADED fuel to the fuel tank.
3. Install the fuel cap and wipe up any spilled gasoline cleanly before starting the engine.



CAUTION

- DO NOT overfill the tank.
- DO NOT fill above the red line indicator. This will allow expansion in hot weather.
- DO NOT fill fuel tank indoors.
- DO NOT fill fuel tank when the engine is running or hot.
- DO NOT light cigarettes or smoke when filling the fuel tank.



Grounding

Your generator must be properly connected to an appropriate ground to help prevent electrical shock.

⚠ WARNING

Failure to properly ground the generator can result in electric shock.

- A ground terminal connected to the frame of the generator has been provided on the power panel. For remote grounding, connect a length of heavy gauge (12 AWG minimum) copper wire between the generator ground terminal and a copper rod driven into the ground. We strongly recommend that you consult with a qualified electrician to ensure compliance with local electrical codes.

4. Operation

Generator Location

⚠ WARNING

- Keep the area clear of inflammables or other hazardous materials.
- Select a place that is dry, well-ventilated, and protected from the weather.
- Keep the exhaust pipe clear of foreign objects.
- Keep the generator away from open flame.
- Keep the generator on a stable and level surface.

⚠ CAUTION

- Tilting can cause fuel spillage.
- DO NOT block the generator air vents.
- Operate this generator **ONLY** outside far away from windows, doors, and vents, to reduce the risk of carbon monoxide gas from potentially accumulating towards occupied spaces.
- Install battery-operated carbon monoxide alarms. Smoke alarms cannot detect carbon monoxide gas.

NOTE

If you start to feel sick, dizzy, or weak while using this generator, shut it off and get to fresh air IMMEDIATELY. See a doctor. You might have carbon monoxide poisoning.

4-1 Starting the Engine

1. Before starting the generator, check for loose or missing parts, and for any damage which may have occurred.
2. Check the oil level and fuel.
3. Disconnect all electrical loads from the generator. NEVER start or stop the generator with electrical devices plugged in.



4. Turn the fuel cap vent level to the "ON" position.

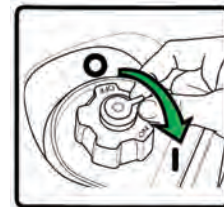

5. Turn the fuel valve to the "ON" position.



6. Set the choke lever to the "START" position.



PM1100i

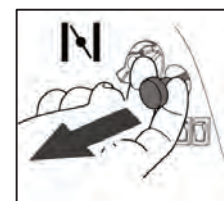

PM2100i

7. Push the engine switch to the "ON" position.

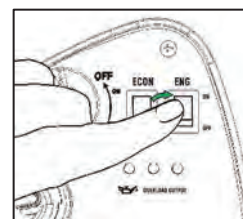

PM1100i

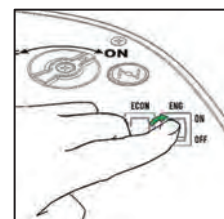

PM2100i

- Pull the recoil starter slowly until resistance is felt, and then pull away.

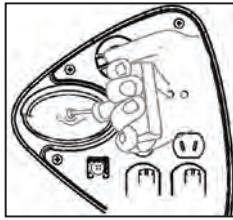

PM1100i

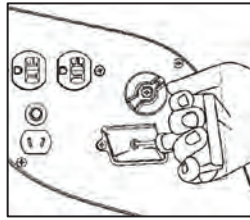

PM2100i

- As soon as the engine warms up, set the choke to the "RUN" position.

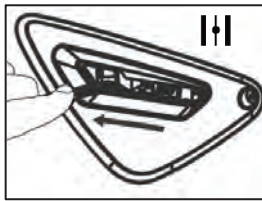

PM1100i



PM2100i

NOTE

Allow the generator to run at no load for a few minutes upon each initial start-up to stabilize the engine.

NOTE

If the engine starts but does not stay running make certain that the generator is on a flat, level surface. The engine is equipped with a low oil sensor that will prevent the engine from running when the oil level falls below a critical threshold.

4-2 Economy Control Switch

The Economy Control switch can be activated in order to minimize fuel consumption and noise while operating the unit during times of **reduced electrical output**, allowing the engine speed to idle during periods of non-use. The engine speed returns to normal when an electrical load is connected. When the economy switch is off, the engine runs at normal speed continuously.

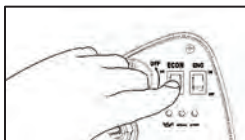

PM1100i



PM2100i

WARNING

For periods of high electrical load or momentary fluctuation, the Economy Controls Switch should be turned OFF.

4-3 Battery Charging

The DC receptacle should **ONLY** be used for charging 12V automotive type batteries. The DC charging output is not regulated. When using the DC output, turn the Eco-Throttle switch to the "OFF" position.

CAUTION

Do not start the vehicle while the battery charging cable is connected and the generator is running. The vehicle or the generator may be damaged.

Be sure all electric devices including the lines and plug connections are in good condition before connection to the generator.

- Before connecting the battery charging cable to a battery that is installed in a vehicle, disconnect the vehicle battery ground cable from the negative (-) battery terminal.
- Plug the battery charging cable into the DC receptacle of the generator.
- Connect the red (+) battery charger lead to the red (+) battery terminal.
- Connect the black (-) battery charger lead to the black (-) battery terminal.
- Start the generator.

4-4 Stopping the Engine

- Turn off and disconnect all electrical loads from the generator. **NEVER** start or stop the generator with electrical devices plugged in.



- Push the engine switch to the "OFF" position.

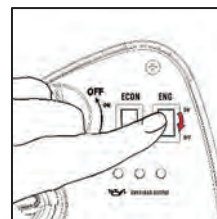

PM1100i

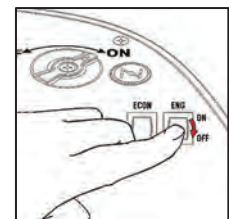

PM2100i

- Turn the fuel valve to the "OFF" position.



- Turn the fuel cap vent lever to the "OFF" position.



- Plug in and turn on the next item.
- Allow the engine to stabilize.
- Repeat steps 5-6 for each additional item.

NOTE

Never exceed the specified capacity when adding loads to the generator.

Wattage Reference Chart

Use the chart to determine approximate wattage requirements for your equipment.

Item	Running Watts (A)	Starting Watts (B)
Essentials		
Light Bulb	100	
Refrigerator/ Freezer	1200	2400
Freezer	500	500
Sump Pump	600	1800
Well Pump 1HP	2000	4000
Water Heater	4000	
Security System	180	
AM/FM Radio	300	
Garage Door Opener 1/2 HP	500	600
Battery Charger 12V DC	110	
Heating/Cooling		
Air Conditioner 12000 BTU	1700	2500
Fan	300	600
Furnace Fan 1/8 HP	1200	2000
Home Appliances		
Microwave 000W	1000	
Electric Range - One Element	1500	
Electric Skillet	1250	
Coffee Maker	1500	
Clothes Washer	1200	
Entertainment		
CD/DVD Player / VCR	100	
Stereo Receiver	450	
Television 27"	500	
PC with 15" Monitor	800	
Job Site		
Belt Sander 3"	1000	1500
Bench Grinder 6"	700	1500
Circular Saw	1500	1500
Compressor 1 1/2 HP	2500	2500
Edge Trimmer	500	500
Hand Drill 1/2"	1000	1000
Lawn Mower	1200	1800
Paint Sprayer	600	1200
Table Saw	2000	2000

Do not Overload the Generator

Capacity

Follow these simple steps to calculate the running and starting watts necessary for your purposes.

- Select the electrical devices you plan on running at the same time.
- Total the running watts of these items. This is the amount of power you need to keep your items running.
- Identify the highest starting wattage of all devices identified in step 1. Add this number to the number calculated in step 2. Surge wattage is the extra burst of power needed to start some electric driven equipment. Following the steps listed under "Power Management" will guarantee that only one device will be starting at a time.

Power Management

Use the following formula to convert voltage and amperage to watts:

$$\text{Volts} \times \text{Amps} = \text{Watts}$$

To prolong the life of your generator and attached devices, follow these steps to add electrical load:

- Start the generator with no electrical load attached.
- Allow the engine to run for several minutes to stabilize.
- Plug in and turn on the first item. It is best to attach the item with the largest load first.
- Allow the engine to stabilize.

Overload Operation

The overload indicator light will turn on when the load exceeds 900W (for PM1100i), or 1600W (for PM2100i). If the load exceeds 1000W (for PM1100i), or 2000W (for PM2100i), the light will blink and cut power to the receptacles in 3 minutes. To recover the power, you must shut off the engine, wait 5 seconds, and restart the generator.

5. MAINTENANCE AND STORAGE

The owner/operator is responsible for all periodic maintenance.

⚠ WARNING

Never operate a damaged or defective generator.

⚠ WARNING

Tampering with the factory set governor will void your warranty.

⚠ WARNING

Improper maintenance will void your warranty.

NOTE

Maintenance, replacement, or repair of emission control devices and systems may be performed by any non-road engine repair establishment or individual.

- Complete all scheduled maintenance in a timely manner. Correct any issue before operating the generator.

5-1 Engine Maintenance

To prevent accidental starting, remove and ground spark plug wire before performing any service.

Oil

Change oil when the engine is warm. Refer to the oil specification to select the proper grade of oil for your operating environment.

1. Loosen the cover screws and remove the maintenance cover.
2. Remove the oil filler cap.
3. Tilt the generator on its side and allow the oil to drain completely.
4. Add 0.34 qt (0.32 U of oil and replace oil fill I cap/dipstick.
5. Reinstall the maintenance cover and tighten the covers screw.
6. Dispose of used oil at an approved waste management facility.

Oil Cont'd

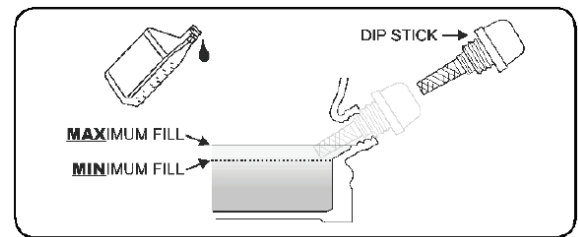

Spark Plugs

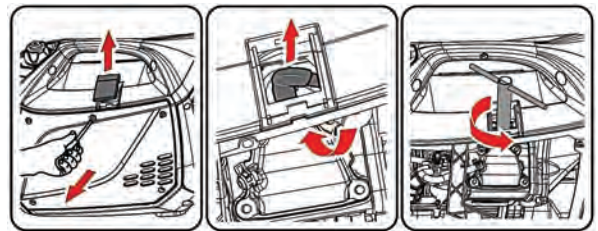

1. Remove the maintenance cover.
2. Remove the spark plug cable from the spark plug.
3. Use the spark plug tool that shipped with your generator to remove the plug. Remove the spark plug access cap and insert the spark plug tool through this hole.
4. Remove the spark plug.
5. Inspect the electrode on the plug. It must be clean and not worn to produce the spark required for ignition.
6. Make certain the spark plug gap is 0.6 - 0.7 mm (0.024 - 0.028 in.).

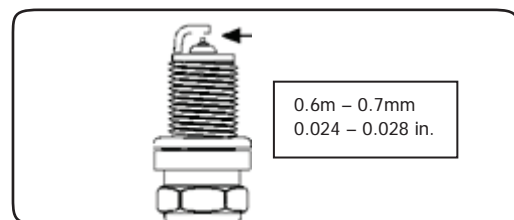

7. Carefully thread the plug into the engine.
8. Use the spark plug tool to firmly install the plug.
9. Attach the spark plug cap to the plug.
10. Reinstall the spark plug access cap, and

maintenance cover.

Air Filter

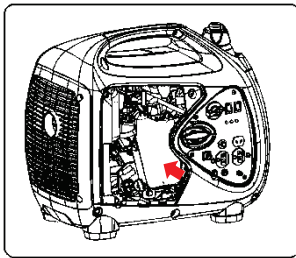

PM1100i

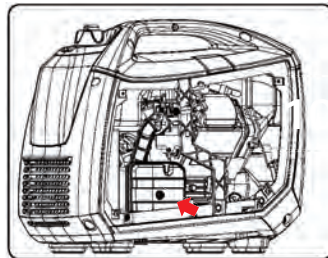

PM2100i

1. Remove the maintenance cover.
2. Locate the air filter plastic cover. Remove the screw using a Phillips head screwdriver.
3. Remove the foam element.
4. Wash in liquid detergent and water. Squeeze thoroughly dry in a clean cloth.
5. Saturate in clean engine oil.
6. Squeeze in a clean, absorbent cloth to remove all excess oil.
7. Place the filter in the assembly.
8. Reattach the air filter cover.
9. Reinstall the maintenance cover and tighten the cover screw securely.

5-2 Cleaning

CAUTION

DO NOT spray engine with water.

Water can contaminate the fuel system.

- Use a damp cloth to clean exterior surfaces of the engine.
- Use a soft bristle brush to remove dirt and oil.
- Use an air compressor (25 PSI) to clear **dirt** and debris from the engine.

Adjustments

The air-fuel mixture is not adjustable. Tampering with the governor can damage your generator and your electrical devices and will void your warranty.

Maintenance Schedule

Follow the service intervals indicated in the following maintenance schedule.

Service your generator more frequently when operating in adverse conditions.

Every 8 hours or daily	
	Check oil level
	Clean around air intake and muffler
Every 8 hours or daily	
	Change oil
Every 8 hours or daily	
	Clean air filter
	Change oil if operating under heavy load or in hot environments
Every 8 hours or daily	
	Change oil
	Clean/Adjust spark plug
	Check/Adjust valve clearance
	Clean spark arrester
	Clean fuel tank and filter
Every 8 hours or daily	
	Replace fuel line

5-3 Generator Maintenance

Make certain that the generator is kept clean and stored properly. Only operate the unit on a flat, level surface in a clean, dry operating environment. DO NOT expose the unit to extreme conditions, excessive dust, dirt, moisture or corrosive vapors.

CAUTION

DO NOT use a garden hose to clean the generator.

Water can enter the generator through the cooling slots and damage the generator windings.

Spark Plugs

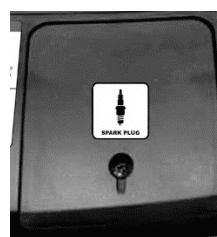

PM1100i

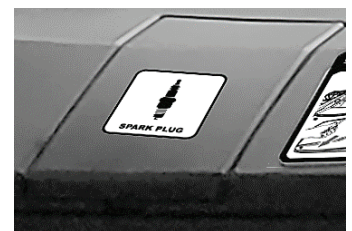

PM2100i

Use a soft bristle brush to remove dirt and oil.
Use an air compressor (25 PSI) to clear dirt and debris from the generator.
Inspect all air vents and cooling slots to ensure that they are clean and unobstructed.

5-4 Service and Storage

Infrequent Service

Difficulty in starting the engine of the generator may result if the unit is used infrequently.

What to do:

1. Run the generator at least 30 minutes every month.
2. Run the generator, then close the fuel shut-off valve and allow the unit to run until the engine stops.
3. Move the engine switch to the “**OFF**” position.

Long Term Storage

When the generator is not being operated or is being stored for more than a month:

1. Allow the engine to cool completely before storage.
2. Clean the generator according to the instructions in the Maintenance section.
3. Remove the maintenance cover. Drain all fuel completely from the fuel line and carburetor to prevent varnish build up.
4. Remove the spark plug cap, then pull the recoil grip 3 times to drain the gasoline from the carburetor jets.
5. Change the engine oil.
6. Remove the spark plug and pour about a tablespoon of oil into the cylinder. Crank the engine slowly to distribute the oil and lubricate the cylinder.
7. Reattach the spark plug.

The generator should be started at least once every 14 days and allowed to run for at least 20 minutes. storage.

NOTE

We recommend using a fuel stabilizer. A fuel stabilizer will minimize the formulation of fuel gum deposits during storage. The fuel stabilizer can be added to the gasoline in the fuel tank, or into the gasoline in a storage container.

WARNING

NEVER use water to clean your generator.

6. SPECIFICATIONS

PM1100i

Engine Specification

- Displacement..... 50cc
- Type..... 4-stroke OHV
- Start Type..... Recoil

Generator Specifications

- Rated Power..... 900 Watts
- Maximum Power..... 1000 Watts
- Phase..... Single
- Fuel Capacity..... 0.74 gallon (2.8L)
- Degree of Protection..... IP23
- Gross Weight..... 43.6lbs. (17.5kg)
- Net Weight..... 33.1lbs. (15kg)
- Height..... 15.8inches (40cm)
- Width..... 11.3inches (28.5cm)
- Length..... 19.2 inches (48.5cm)

Fuel

Fuel capacity is 0.74 gallon (2.8 L). Use regular unleaded gasoline with a minimum octane rating of 85 and an ethanol content of less than 10% by volume.

Oil

Use 10W-30 4-Cycle automotive oil. Oil capacity is 0.34 qt (0.32L). Please reference the following chart for recommended oil types for use in the generator.

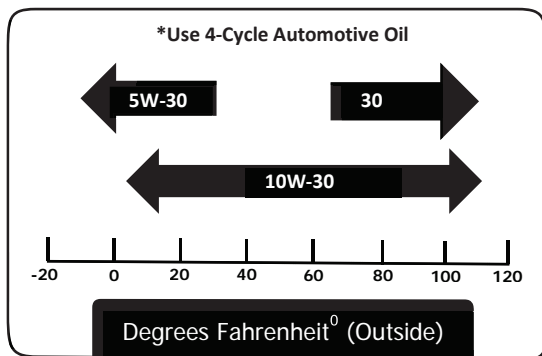

Spark Plugs

Recommended replacement spark plug:

- **NGK CR4HSB or equivalent**

Make certain the spark plug gap is 0.6 - 0.7 mm or (0.024 - 0.028 in.).

Valve Clearance

Intake: 0.08 - 0.10 mm (0.003 - 0.004 in.)

- Exhaust: 0.08 - 0.10 mm (0.003 - 0.004 in.)

PM2100i

Engine Specification

- Displacement..... 80cc
- Type..... 4-stroke OHV
- Start Type..... Recoil

Generator Specifications

- Rated Power..... 1600 Watts
- Maximum Power..... 2000 Watts
- Phase..... Single
- Fuel Capacity..... 0.9 gallon (3.4L)
- Degree of Protection..... IP23
- Gross Weight..... 60.8lbs. (27.6kg)
- Net Weight..... 44lbs. (20kg)
- Height..... 16.7inches (42.5cm)
- Width..... 11.6inches (29.5cm)
- Length..... 19.1 inches (48.5cm)

Fuel

Fuel capacity is 0.9 gallon (3.4 L). Use regular unleaded gasoline with a minimum octane rating of 85 and an ethanol content of less than 10% by volume.

Oil

Use 10W-30 4-Cycle automotive oil. Oil capacity is 0.42 qt (0.4L). Please reference the following chart for recommended oil types for use in the generator.

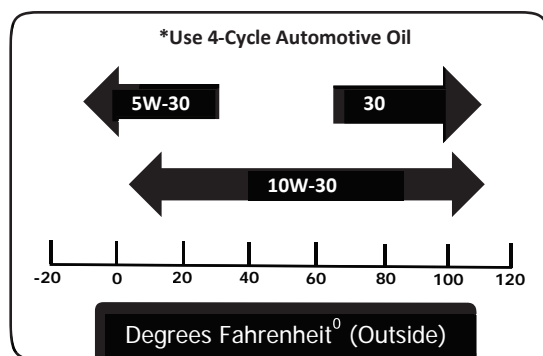

Spark Plugs

Recommended replacement spark plug:

- **NHSP E6RTC, NGK BPR6HS or equivalent**

Make certain the spark plug gap is 0.6 - 0.7 mm or (0.024 - 0.028 in.).

Valve Clearance

Intake: 0.1 mm (0.004 in.)

- Exhaust: 0.1 mm (0.004 in.)

7. TROUBLESHOOTING

Problem	Cause	Solution
Generator will not start	No fuel	Add fuel
	Faulty spark plug	Replace spark plug
	Unit loaded during start up	Remove load from unit
Generator starts but runs roughly	Low oil level	Fill crankcase to the proper level
		Place generator on a flat, level surface
	Choke in the wrong position.	Adjust choke.
	Spark plug wire loose	Attach wire to spark plug
Generator shuts down during operation	Out of fuel	Fill fuel tank
	Low oil level	Fill crankcase to the proper level. Place generator on a flat, level surface
Generator cannot supply enough power or overheating	Generator is overloaded	Review load and adjust. See "Power Management"
	Insufficient ventilation	Check for air restriction. Move to a well-ventilated area
No AC output	Cable not properly connected	Check all connections
	Connected device is defective	Replace defective device
	Circuit breaker is open	Reset circuit breaker
	Faulty brush assembly	Replace brush assembly (Service Center)
	Faulty AVR (auto voltage regulator)	Replace AVR (Service Center)
	Loose wiring	Inspect and tighten wiring connections
	Other	Contact the help line.
Repeated circuit breaker tripping	Overload	Review load and adjust. See "Power Management"
	Faulty cords or device	Check for damaged, bare or frayed wires. Replace defective device

8. SERVICE INFORMATION

HOW TO ORDER REPLACEMENT PARTS

Even quality-built equipment such as the generator you have purchased will need occasional replacement parts to maintain its good condition over the years.

To order replacement parts and consumable parts, please contact Promate Service (details below) and be ready with the following information:

1. Model No., Serial No. and all specifications that are shown on the Model No./Serial No. plate.
2. Part number or numbers as shown in the Parts List section.
3. A brief description of the trouble with the generator.

LIMITED WARRANTY

Warranty Coverage: Powertech Asia Pacific Inc., (the Company) warrants to the original retail customer that it will repair or replace, free of charge, any parts found by the Company or its authorized service representative to be defective in material or workmanship. This warranty covers the cost of replacement parts and labor for defects in material or workmanship.

Not Covered:

- Shipping/Handling charges for sending the product to the Company or its authorized service representative for warranty service. Shipping/Handling repaired or replaced products back to the customer; these charges must be borne by the customer.
- If a separate operator's manual and engine warranty from the engine manufacturer is included with this product, only that warranty will apply to the engine.
- Damage caused by abuse, accident, the effects of corrosion, erosion and normal wear and tear.

- Warranty is void if the customer fails to install, maintain and operate the product in accordance with the instructions and recommendations of the Company set forth in the owner's manual, or if the product is used as rental equipment.
- The Company will not pay for repairs or adjustments to the product, or for any costs of labor performed without the Company's prior authorization.
- Consumable parts such as battery, spark plugs, and air cleaner.

Warranty Period: One (1) year from the date of purchase on products used solely for consumer applications; if a product is used for business or commercial applications,

the warranty period will be limited to ninety (90) days from the date of purchase.

For warranty service, the customer must provide dated proof of purchase and must notify the Company within the warranty period.

EXCLUSIONS AND LIMITATIONS: THE COMPANY MAKES NO OTHER WARRANTY OF ANY KIND, EXPRESS OR IMPLIED. IMPLIED WARRANTIES, INCLUDING WARRANTIES OF MERCHANTABILITY AND OF FITNESS FOR A PARTICULAR PURPOSE, ARE HEREBY DISCLAIMED. THE WARRANTY SERVICE DESCRIBED ABOVE IS THE EXCLUSIVE REMEDY UNDER THIS WARRANTY; LIABILITY FOR INCIDENTAL AND CONSEQUENTIAL DAMAGES IS EXCLUDED TO THE EXTENT

PERMITTED BY LAW.

This warranty gives you specific legal rights, and you may also have other rights which vary from state to state. Some states do not allow a disclaimer of implied warranties or the exclusion or limitation of incidental and consequential damages, so the above disclaimers and exclusions may not apply to you.



CONTACT THE POWERTECH Asia Pacific Inc.,
PRODUCT SERVICE DEPARTMENT AT (02) 8 638 1569 | (+63) 9338373922
service@powertechasiapacific.com www.facebook.com/PromateServicePH/



Parts Diagram: Promate PM1100i

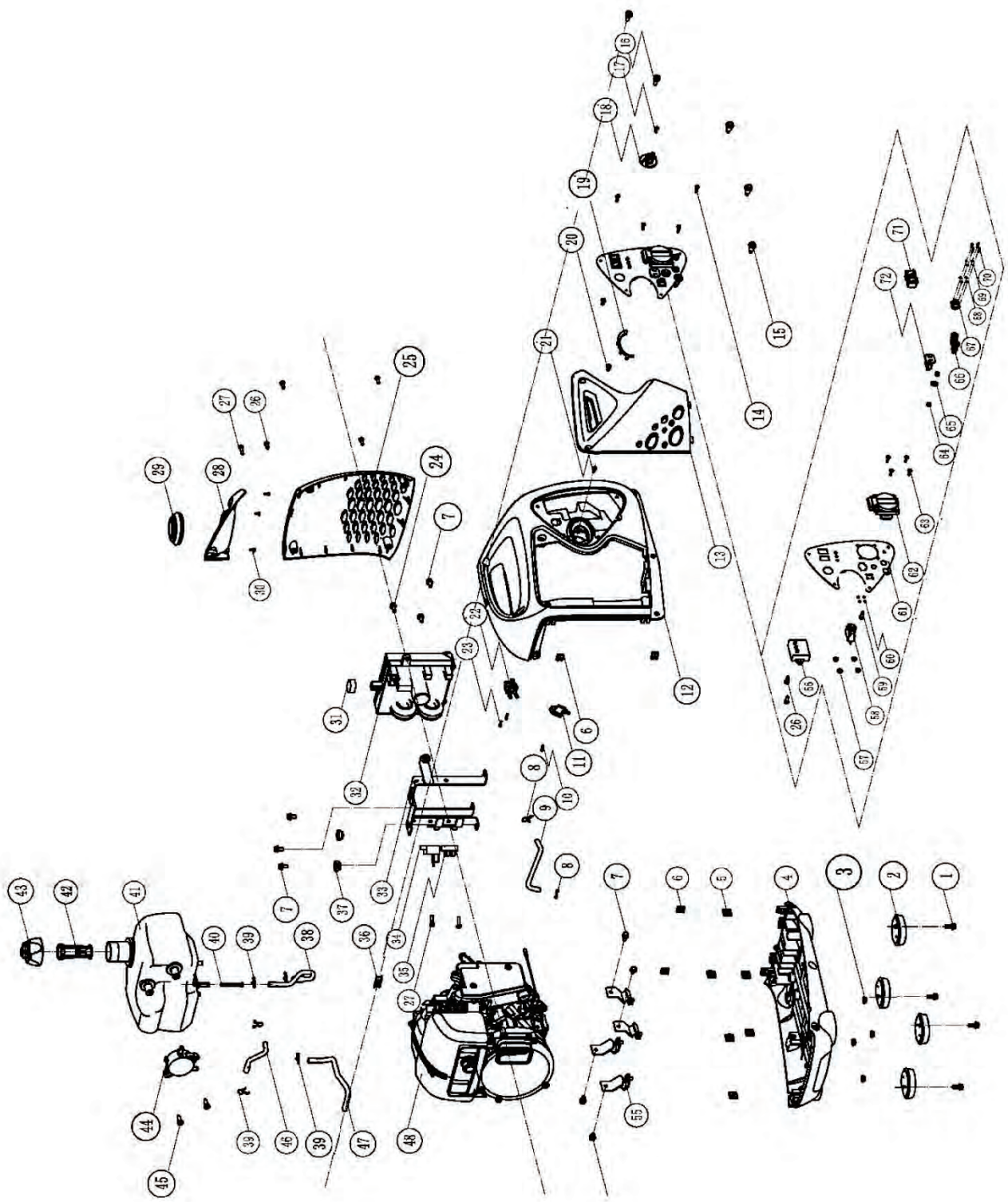

Parts List: Promate PM1100i

No.	Alias	Description	Qty
1	GB5789 M6X15	FLG. BOLT M6 y 15	4
2	0910.200604.30	MOUNT RUBBER BASE SETTING	4
3	GB61177.1 m6	NUT M6	4
4	0910.200601.30	BASE SETTING	1
5	02.006002.00	NUT M6	6
6	02.005002.00	NUT M5	9
7	GB5789 M6X12	FLG. BOLT M6 Y 12	7
8	06.009001.10	Clip	3
9	0910.070011.09	PIPE FUEL	1
10	GB845 ST3.5X13	SELF-TAPPING SCREW 3.5X13	1
11	0910.126100.00	TCI UNIT	1
12	0910.200101.30	FRONT COVER ASSY	1
13	0910.200105.30	MAINTENANCE COVER	1
14	GB9074.4 M4X14	SCREW&WASHER ASSY M4 y 14	6
15	08.006002.00	BOLT M6 y 20	4
16	GB818 M6X20	SCREW M6 y 20	2
17	GB818 M4X10	SCREW M4 y 10	1
18	168.070001.00	FUEL KNOB	1
19	0910.200106.30	PROTECTOR	1
20	GB818 M5X10	SCREW M6 y 10	2
21	GB823 M4X14	SCREW M4X14	1
22	0910.070400.00	FUEL COCK COMP.	1
23	GB845 ST2.9X13	SELF-TAPPING SCREW 2.9X13	2
24	GB5789 M6X16	FLG. BOLT M6 y 16	1
25	0910.200300.31	COVER RH(LOWER)	1
26	GB818 M5X14	SCREW M5 y14	10
27	GB818 M5X20	SCREW M5 y 20	3
28	0910.200300.30	COVER RH (UPPER)	1
29	0910.200502.30	SETTING, SPILL PREVENTION	1
30	GB845 ST3.5X13	SELF-TAPPING SCREW 3.5X9.5	3
31	0902.220002.00	MOUNT RUBBER, CONTROLER	1
32	0910.221000.31	CONTROLER ASSY	1
33	0910.070009.30	BRACKET, FUEL TANK	1
34	IV02.P-00000000	PARALLEL TERMINAL	1
35	504.190600.00	RECTIFIER	1
36	0910.200024.00	FIXED NUT	1
37	14.008095.00	BUFFER	2
38	0910.070011.05	PIPE, FUEL	1
39	06.105001.10	CLIP	4
40	152.070300.01	PIPE, FUEL	1
41	0910.071000.30	FUEL TANK ASSY	1
42	0910.070300.00	FUEL FILTER	1
43	0902.070300.00	FUEL TANK CAP COMP.	1
44	0910.073000.00	FUEL PUMP ASSY	1
45	GB845 ST6.3X22	SELF-TAPPING SCREW 6.3X22	2
46	0910.070011.07	PIPE, FUEL	1
47	0910.070900.00	DIAPHRAGM TUBE COMP.	1
48	0910.B1	ENGINE	1
49	0910.200401.30	SUPPORTER, BACK COVER	1
50	0910.200505.30	MAINTENANCE COVER	1
51	GB818 M5X16	SCREW M5 y 16	1
52	GB845 ST4.2X16	SELF-TAPPING SCREW 4.2X16	1
53	0910.200200.30	COVER COMP. LH.	1
54	GB5789 M6X8	FLG. BOLT M6 y 8	2
55	0902.200605.00	MOUNT RUBBER, ENGINE	4
56	0910.210016.00	SPEED LIMITER	1

No.	Alias	Description	Qty
57	GB6177 M4	NUT M4	4
58	ST02FD-05302007	OVERLOAD PROTECTOR (10A)	1
59	GB5783 M5X14	NUT M5 y 14	1
60	GB6170 M2	NUT M2	4
61	0910.210100.30	PANEL COMP.	1
62	ST02FD-05502007	PLUG BASE	1
63	GB819 M4U14	SCREW M4 y 14	4
64	GB41 M5	NUT M5	2
65	GB97.1° 5	FLAT WASHER ≅ 5	1
66	0902.210001.00	PARALLEL TERMINAL	2
67	22.012001.02	COMMUNICATION RECEPTACLE	1
68	GB97.1° 2	FLAT WASHER ≅ 2	4
69	GB859	SPRING WASHER ≅ 2	4
70	GB818 M2X10	SCREW M2 y 10	4
71	21.003000.10	SWITCH FLAMEOUT	2
72	ST02FD-05402001	SOCKET (12V)	1

Engine Parts Diagram: Promate PM1100i

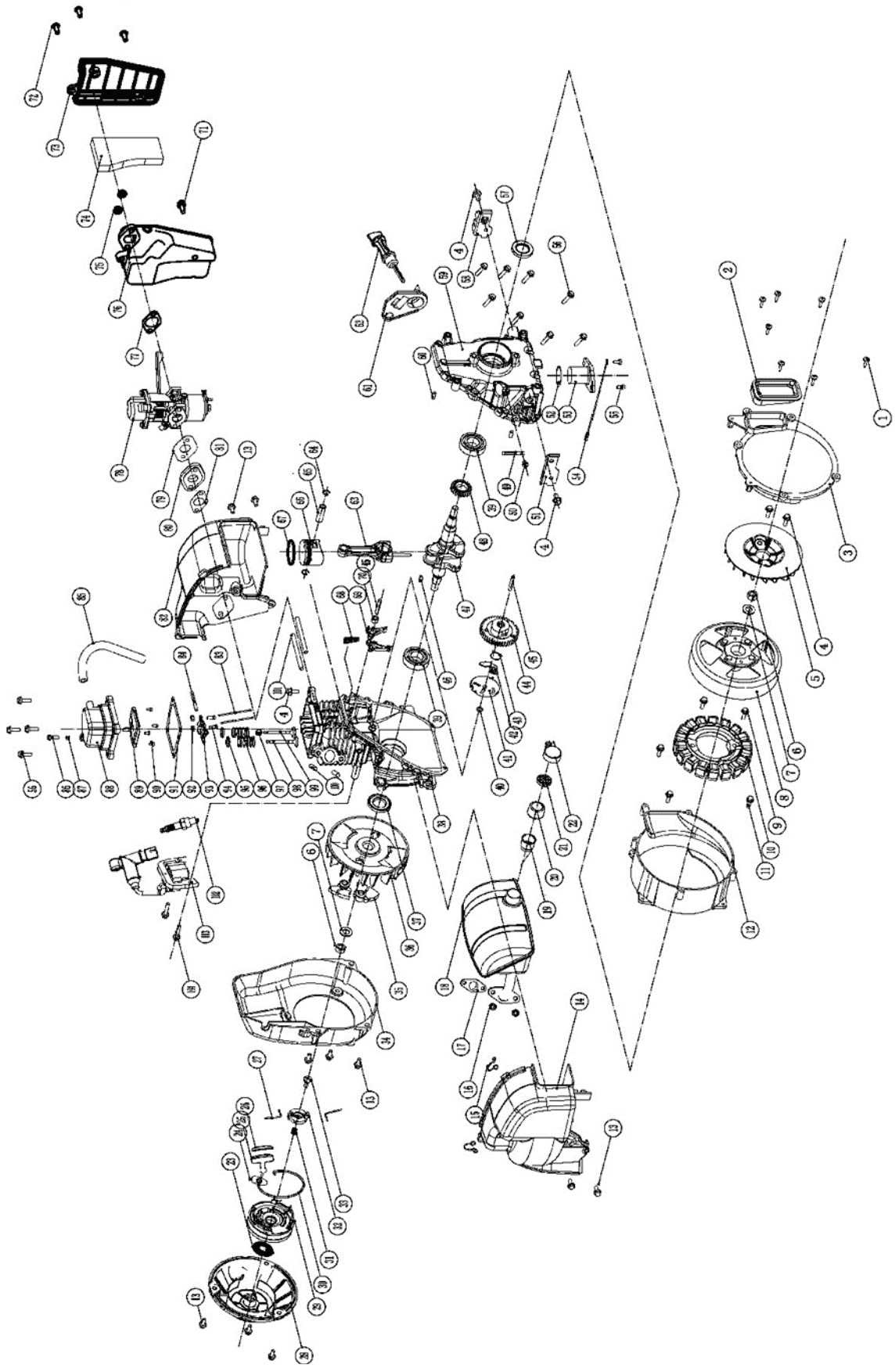

Engine Parts List: Promate PM1100i

No.	Alias	Description	Qty
1	GB845 ST4.8X16	SELF-TAPPING SCREW ST4. 8X16	7
2	0910.190006.00	RUBBER, END COVER	1
3	0910.190003.00	GENERATOR END COVER	1
4	GB5789 M6X12	FLG. BOLT M6X12	5
5	0910.190001.00	FAX, ENGINE	1
6	GB6170 M10X1.25	HEX. NUT M10	2
7	GB97.1 @0/	WASHER Φ 10	2
8	0910.191200.00	ROTOR COMP.	1
9	GB9074.14 M6X25	SCREW&WASHER ASSY M6X25	2
10	0910.191100.30	STATOR COMP.	1
11	GB5789 M5X16	FLG. BOLT M5X16	3
12	0910.190002.00	END COVER	1
13	GB5789 M5X12	FLG. BOLT M5X12	10
14	0910.081300.00	MUFF. PROTECTOR ASSY RH	1
15	0910.080008.00	SPRING	2
16	GB6175 M6	HEX. NUT M6	2
17	0902.100001.00	GSKT., EXT.	1
18	0910.101100.00	MUFF., SYS.	1
19	0910.101300.00	COVER, UNDERSIDE	1
20	0902.101501.00	CAP, MUFF	1
21	0902.101502.00	METAL FILTER, EX.	1
22	06.025002.20	CLIP	1
23	0910.061006.00	SPRING, STARTER RETURN	1
24	0910.061200.30	GUIDE, ROPE HANDLE	1
25	0910.061005.00	GRIP, STARTER	1
26	0910.061012.00	COVER, GRIP	1
27	0910.061002.00	PATCHET, STARTER	2
28	0910.061100.00	CASE COMP., RECOIL STARTER	1
29	0910.061001.00	PULLEY, RECOIL STARTER	1
30	10.351400.00	ROPE	1
31	0910.061009.00	SPRG. PAW; GUIDE	1
32	0910.061007.00	PAWL GUIDE	1
33	0910.061008.00	SCREW, PAWL GUIDE	1
34	0910.061009.00	FAN COVER COMP.	1
35	0910.080100.00	BUILD UP, FLYWHEEL	2
36	0910.120100.00	FLYWHEEL COMP.	1
37	12.020038.10	OIL SEAL	1
38	0910.030100.00	CRANKCASE	1
39	GB/T 276 6004/P6	BEARING	2
40	ST160F-1110106	INNER WASHER, GEAR	1
41	0910.040106.00	COVER, CAM	1
42	0910.040104.00	FLYWEIGHT	1
43	0910.040103.00	SPRING DECOMPRESS	1
44	0910.040107.00	CAM	1
45	0910.040101.00	CAM SHAFT	2
46	GB1099. 1 3X5X13	SEM. KEY	1
47	0910.050101.00	CRANKSHAFT	1
48	0910.050102.00	GEAR, DRIVE	1
49	ST188F-1030001	CLIP, WIRE	1
50	GB9074.3 M5X10	SCREW&SPR WASHER ASSY. M5X10	1
51	0910.127000.00	BOARD	1
52	07.265265.10	O-RING@15-4 O @1-54	1
53	0910.127000.00	OIL LEVER SWITCH	1
54	0910.120300.00	WIRE, FLAMEOUT	1
55	GB9074. 15 M6X16	SCREW&WASHER ASSY M6X16	2
56	GB5789 M5X20	FLG. BOLT M5X20	12

No.	Alias	Description	Qty
57	12.020000.01	OIL SEAL	1
58	0910.030036.20	BOARD	1
59	0910.030007.00	COVER, CRANKCASE	1
60	139FMD-1001001	PIN DAWL	2
61	0910.030035.00	OIL NOZZLE	1
62	0910.031000.00	OIL DIPSTICK ASSY.	1
63	0910.050200.00	CONN, ROD COMP.	1
64	09.113001.00	CLIP, PISTON PIN	2
65	0910.050003.00	PIN, PISTON	1
66	0910.050005.00	PISTON	1
67	0910.050300.00	PISTON RING SET	1
68	0910.041002.00	ELEMENT	1
69	0910.041002.00	VALVE LIFTER	2
70	15.052076.10	BUSH Φ 5.2	1
71	GB5789 M6X15	FLG. BOLT M6X15	1
72	08.006016.10	BOLT M6X16	3
73	0910.091200.30	CASE, AIR CLEANER	1
74	0910.091003.30	ELEMENT	1
75	GB6177.1 M6	HEX. NUT M6	2
76	0910.091100.30	CASE, AIR CLEANER COMP.	1
77	0910.130004.00	GSKT., AIR CLEANER	1
78	0910.130000.00	CARBURETOR COMP.	1
79	0910.130003.00	GSKT., CARB	1
80	0910.130001.00	INSULATOR, CARB.	1
81	0902.130002.00	GSKT., INSULATOR	1
82	0910.081100.00	MUFF., PROTECTOR COMP., SIDE	1
83	0910.040005.00	PUSH ROD, VALVE	2
84	0910.040016.00	SHAFT, ROCKER ARM	1
85	0910.020001.00	TUBE, BREATHER	1
86	GB818 M5X14	SCREW M5X14	1
87	15.005005.10	BUSH Φ 5X5	1
88	0910.021101.00	COVER, CYL. HEAD	1
89	0910.021002.00	COVER, BREATHER ROOM	1
90	GB818 M3X6	SCREW M3X16	4
91	0910.020002.00	PACKING, HEAD COVER	1
92	02.005001.00	NUT, VALVE ADJUSTING	2
93	0910.040009.00	ROCKER ARM, VALVE	2
94	0910.040012.00	NUT, VALVE ADJUSTING	2
95	0910.040007.00	RET., VALVE SPRING (IN.)	1
96	0910.040003.00	SPRING, VALVE	2
97	0910.040017.00	OIL SEAL, VALVE	1
98	0910.040006.00	VALVE, EX.	1
99	0910.040002.00	VALVE, IN.	1
100	01.606002.00	STUD. BOLT	2
101	01.060680.10	STUD. BOLT	2
102	A5RTC	SPARK PLUG	1
103	0910.123000.01	IGNITION ASSY.	1
104	GB5789 M5X25	FLG. BOLT M5X25	2

Parts Diagram: Promate PM2100i

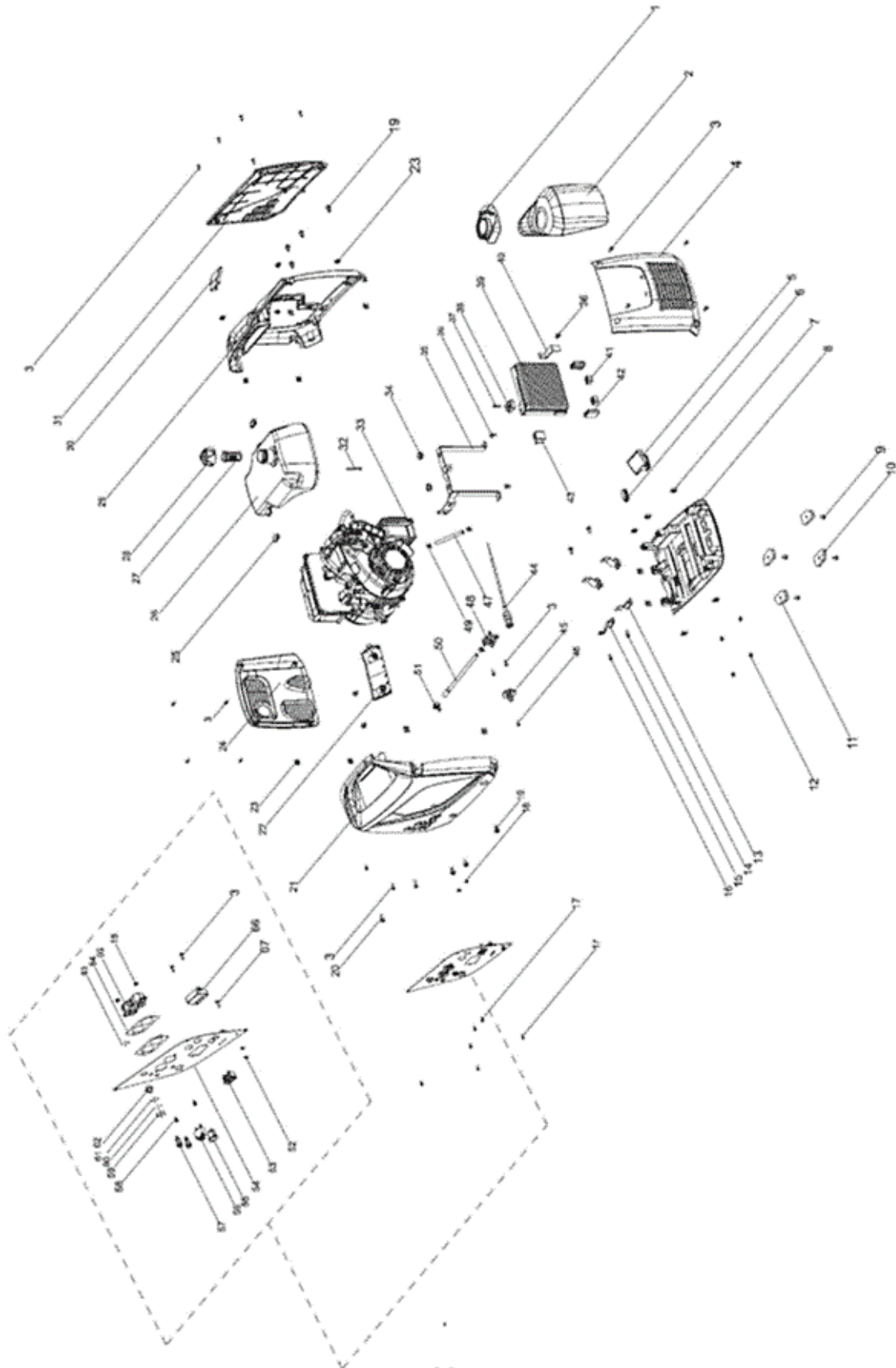

Parts List: Promate PM2100i

No.	Alias	Description	Qty
1	0902.200502.20	FUEL GUIDE PLATE	1
2	0902.200500.20	COVER, TOP	1
3	GB/T 818 M5%x14-A	SCREW M5X14	17
4	0902.200300.20	RIGHT SIDE COVER ASSY (RAL 9005)	1
5	0902.200612.20	PASSAGEWAY, ALR CLEANER	1
6	0902.200613.20	PASSAGEWAY, ELECTRIC MACHINERY	1
7	GB/T 39 M6	NUT M6	9
8	0902.200600.20	BASE ASSY (RAL9005)	1
9	08-6*12	BOLT M6X12	4
10	0902.200603.20	BASE, MOUNTING	2
11	0902.200604.20	BASE, MOUNTING	2
12	GB/T 6177.1 M6-A	NUT M6	4
13	0902.200605.00	SHOCK ABSORBER	3
14	GB 5789 M6%x15	BOLT M6X 15	3
15	0902.200605.20	SHOCK ABSORBER	1
16	GB/T 819 M6%x14	SCREW M6X 15	1
17	GB/T 9074.8 M4%x14-A	SCREW M4X 14	6
18	6177.1-4	NUT M4	4
19	0902.200028.00	BOLT M6	9
20	GB/T 818 M6%x20-A	SCREW M6X20	2
21	0902.200100.20	FRONT COVER ASSY (RAL 9005)	1
22	0902.200022.20	FRONT BRIDGE	1
23	0902.200024.00	NUT M5	13
24	0902.200200.20	LEFT SIDE COVER ASSY (RAL9005)	1
25	0902.070015.20	MOUNTING, FUEL TANK	2
26	0902.071000.21	FUEL TANK ASSY	1
27	0910.070300.00	FULL FILTER	1
28	0902.070100.20	FUEL TANK CAP COMP	1
29	0902.200400.20	SUPPORTER, BACK COVER	1
30	0902.200505.20	MAINTENANCE COVER	1
31	0902.200105.21	MAINTENANCE COVER RAL (9005)	1
32	0902.070006.00	FUEL PIPE	1
33	0902.20	ENGINE	1
34	14.008095.00	BUFFER	2
35	0902.070009.20	FUEL TANK BRACKET PLATE	1

No.	Alias	Description	Qty
36	GB 5789 M6%x12	HEXAGON FLANGE BOLTS M6X12	3
37	GB/T 9074.17 M5%x20	BOLT ASSEMBLY M5X20	1
38	504.190600.00	BRIDGE STACK	1
39	0902.220V 60Hz 12V	CONTROLLER	1
40	0902.220003.20	CONTROLLER PLATEN	1
41	0902.220002.00	CONTROLLER DAMPING BLOCK	2
42	0902.220001.00	CONTROLLER JACKET	2
44	0902.130200.20	DAMPER ROD ASSEMBLY	1
45	0902.070001.01	OIL SWITCH KNOB	1
46	GB/T 818 M4%x10	SCREW M4 X10	1
47	0902.070011.01	FUEL PIPE 1	1
48	0902.070400.02	OIL SWITCH ASSEMBLY	1
49	06-8.7*8	CLAMP 1	2
50	0902.070011.00	FUEL PIPE 2	1
51	06-12*8	CLAMP 2	1
52	GB/T 6175 M5-A	HEX NUT M5 BLACK ZINC PLATED	2
53	21-03A-01.02	ENGINE SWITCH	2
54	0902.210100.C21	PANEL COMPONENTS	1
55	22-AC-10	12V SOCKET	1
56	23-05-8.1	8A AC CIRCUIT BREAKER	1
57	1006.210001.01	PARALLEL TERMINAL	2
58	04.21.021	PAN HEAD SCREW M5x14	2
59	04.25.038	SMALL PAN HEAD SCREW M3x10	4
60	04.25.038.01	FLAT PAD	4
61	04.25.038.02	SPRING PAD	4
62		AVIATION SOCKET (4 CORES)	1
63	6177-3	HEXAGON FLANGE FACE NUT M3	4
64	504.210015.01	INSULATING PAPER	2
65	22-N-16	SOCKET	2
66	0902.126000.00	IGNITION UNIT	1
67	GB/T 5783 M5%x16-A	HEXAGON HEAD BOLTS M5X16	1
67	0902.070009.20	FUEL TANK BRACKET PLATE	1

Engine Parts Diagram: Promate PM2100i

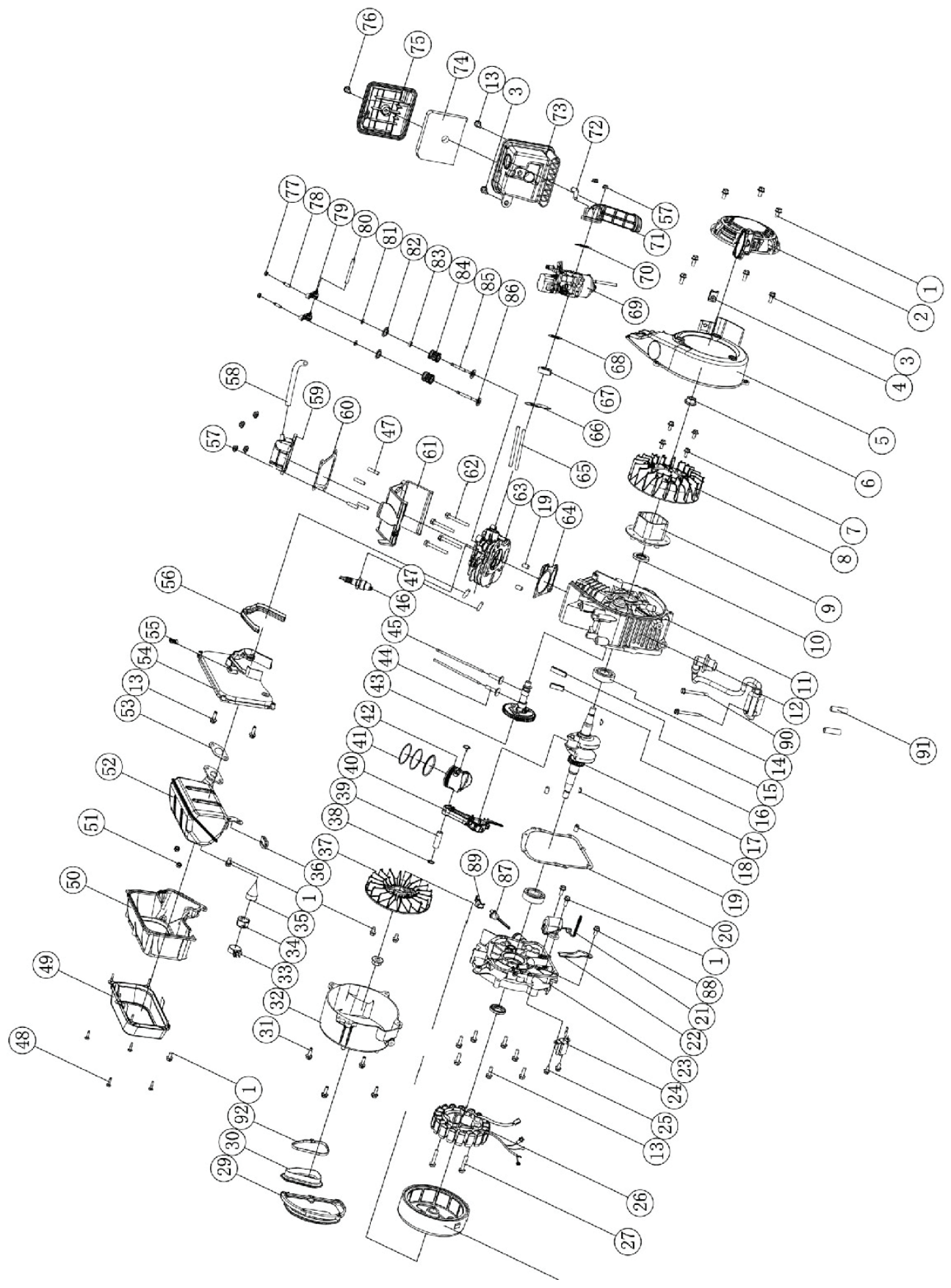

Engine Parts List: Promate PM2100i

No.	Alias	Description	Qty
1	GB5789 M6X12	BOLTE M6X12	9
2	0902.061000.20	STARTER ASSY.	1
3	GB5789 M6X15	BOLT M6X15	5
4	02.006001.00	NUT	1
5	0902.080100.20	AIR SHROUD COMP.	1
6	02.012000.10	NUT M12	2
7	GB16674 M5X12	BOLT M5X12	4
8	0902.080001.00	FAN CASE	1
9	0902.060001.00	STARTING HUB	1
10	12.020000.01	OIL SEAL	2
11	0902.030100.00	CRANKCASE COMP.	1
12	0902.123000.01	IGNITION ASSY.	1
13	GB5789 M6X20	BOLT M6X20	10
14	GB276 6204	BEARING	2
15	0902.030013.01	PROTECTOR COVER SEAL 2	1
16	0902.030013.00	PROTECTOR COVER SEAL 1	1
17	0902.050100.00	CRANK COMP.	1
18	16.003001.00	KEY	2
19	139FMD-1001001	DAWL PIN	4
20	0902.030008.00	CRANKCASE GASKET	1
21	0902.127000.00	OIL LEVEL SWITCH	1
22	0902.030010.00	OIL LEVEL SWITCH PLATE	1
23	0902.030007.00	CRANKCASE COVER	1
24	0902.122000.00	TRIGGER ASSY.	1
25	GB16674 M6X12	BOLT M6X12	2
26	0902.191100.02	STATOR COMP.	1
27	GB5789 M6X35	BOLT M6X35	2
28	0902.191200.00	ROTOR COMP.	1
29	0902.190006.01	RUBBER, END COVER 2	1
30	0902.190006.00	RUBBER, END COVER 1	1
31	GB5789 M6X22 03	BOLT M6X22	4
32	0902.190002.00	END COVER	1
33	06.025001.20	SPARK ARRESTER CLAMP	1
34	0902.101501.00	SPARK ARRESTER BASE	1
35	0902.101300.00	SPARK ARRESTER	1
36	0902.081002.00	RUBBER SEAL	1
37	0902.190001.00	GENERATOR FAN	1
38	09.011001.00	PISTON PIN CLIP	2
39	0902.050003.00	PISTON PIN	1
40	0902.050200.00	CONN. ROD ASSY.	1
41	0902.050300.00	PISTON RING SET	1
42	0902.050005.00	PISTON	1
43	0902.040100.00	CAMSHAFT COMP.	1
44	0902.040013.00	VALVE LIFTER	2
45	0902.040005.00	PUSH ROD	2
46	E6RTC	SPARK PLUG	1
47	01.606002.00	EXHAUST BOLT	6
48	GB845 ST4.8X17		4
49	0902.081300.00	MUFF. PROTECTOR ASSY. RH	1
50	0902.081200.20	MUFF. PROTECTOR ASSY. MIDDLE	1
51	GB6175 M6 03	NUT	2
52	0902.101100.00	MUFF. COMP.	1
53	0902.100001.00	EXHAUST GASKET	1
54	0902.081100.20	PROTECTOR MUFF. SIDE	1

No.	Alias	Description	Qty
55	0902.081003.00	SETTING FLASH BOARD	1
56	0902.081001.00	MUFF. PROTECTOR SEAL	1
57	GB6177.1 M6 03	NUT	6
58	0902.020001.00	BREATHER PIPE	1
59	0902.021000.20	CYL. HEAD COVER ASSY.	1
60	0902.020002.00	CYLINDER COVER GASKET	1
61	0902.080200.00	AIR SHROUD CYLINDER COMP.	1
62	GB5789 M6X50	BOLT M6X50	4
63	0902.010100.00	CYLINDER HEAD COMP.	1
64	0902.030009.00	GASKET, CYLINDER	1
65	01.606001.00	CARBURETOR BOLT	2
66	0902.130002.00	GSKT, INSULATOR	1
67	0902.130001.00	INSULATOR, CARB.	1
68	0902.130003.00	GSKT, CARB	1
69	0902.130000.00	CARB. ASSY.	1
70	0902.130004.00	GSKT, AIR CLEANER	1
71	0902.090004.00	PIPE, AIR CLEANER	1
72	0902.090003.00	JT. BREATHER PIP	1
73	0902.091100.00	CASE, AIR CLEANER COMP.	1
74	0902.091003.00	ELEMENT	1
75	0902.091200.00	CASE, AIR CLEANER	1
76	08.006020.00	BOLT M6X20	1
77	02.005001.00	NUT, VALVE ADJUSTING	2
78	0902.040012.00	SCREW, VALVE ADJUSTING	2
79	0902.040009.00	ARM, VALVE ROCKER	2
80	0902.040016.00	SHAFT, SCREW ROCKER	1
81	CT166FD-1040003	LOCK CLIP, VALVE	2
82	CT166FD-1040004	RET., VALVE SPRING	2
83	0902.040017.00	OIL SEAL, VALVE	1
84	CT166FD-1040005	SPRING, VALVE	2
85	0902.040002.00	VALVE, INTAKE	1
86	0902.040006.00	VALVE, EXHAUST	1
87	0902.030001.00	OIL FILLER CAP ASSY.	1
88	GB5789 M6X8	BOLT M6X8	1
89	0902.030035.00	OIL NOZZLE	1
90	GB5789 M6X60	BOLT M6X60	2
91	15.007003.00	MUFF.	1
92		NYLON CORD	1